



YIHUA

PART NAME: BTA/B16

ISSUE DATE:2010-03-13

Establishment: Carolyn

绍兴怡华电子科技有限公司

■ 主要特点:

符号	数值	单位
IT (RMS)	16	A
V_{DRM}/V_{RRM}	600&800	V
IGT (Q1)	5~50	mA

■ 用途:

BTB/BTA16 双向可控硅系列适用于一般交流开关电路,如:固态继电器,感应马达启动控制,调温控制,调光控制,调速控制...等.

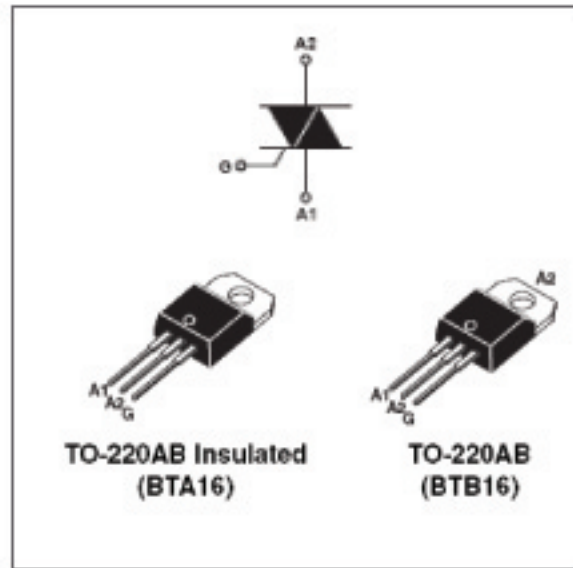

■ 极限值:

符号	参数		数值	单位
I_{T(RMS)}	RMS 通态电流	T_c=100℃	16	A
I_{TSM}	通态峰值浪涌电流	F=50Hz, t=20ms	160	A
I_t	I_t 耗散值	T_p=10ms	144	A²s
di/dt	通态电流上升值	F=120Hz, T_j=125℃	50	A/μs
I_{GM}	门极峰值电流	TP=20μs, T_j=125℃	4	A
P_{G(AV)}	平均门极耗散功率	T_j=125℃	1	W
T_{stg}	贮存结温范围		-40~+150	℃
T_j	工作结温范围		-40~+125	℃

■ 电特性

■ SNUBBERLESS and Logic Level (3 quadrants)

Symbol	Test Conditions	Quadrant		T16	BTA16 / BTB16			Unit
				T1635	SW	CW	BW	
I_{GT} (1)	$V_D = 12\text{ V}$ $R_L = 33\ \Omega$	I - II - III	MAX.	35	10	35	50	mA
V_{GT}		I - II - III	MAX.	1.3			V	
V_{GD}	$V_D = V_{DRM}$ $R_L = 3.3\text{ k}\Omega$ $T_j = 125^\circ\text{C}$	I - II - III	MIN.	0.2			V	
I_H (2)	$I_T = 500\text{ mA}$		MAX.	35	15	35	50	mA
I_L	$I_G = 1.2 I_{GT}$	I - III	MAX.	50	25	50	70	mA
		II		60	30	60	80	
dV/dt (2)	$V_D = 67\% V_{DRM}$ gate open	$T_j = 125^\circ\text{C}$	MIN.	500	40	500	1000	V/ μs
$(dI/dt)_c$ (2)	$(dV/dt)_c = 0.1\text{ V}/\mu\text{s}$	$T_j = 125^\circ\text{C}$	MIN.	-	8.5	-	-	A/ms
	$(dV/dt)_c = 10\text{ V}/\mu\text{s}$	$T_j = 125^\circ\text{C}$		-	3.0	-	-	
	Without snubber	$T_j = 125^\circ\text{C}$		8.5	-	8.5	14	

■ Standard (4 quadrants)

Symbol	Test Conditions	Quadrant		BTA16 / BTB16		Unit
				C	B	
I_{GT} (1)	$V_D = 12\text{ V}$ $R_L = 33\ \Omega$	I - II - III IV	MAX.	25 50	50 100	mA
V_{GT}		ALL	MAX.	1.3		V
V_{GD}	$V_D = V_{DRM}$ $R_L = 3.3\text{ k}\Omega$ $T_j = 125^\circ\text{C}$	ALL	MIN.	0.2		V
I_H (2)	$I_T = 500\text{ mA}$		MAX.	25	50	mA
I_L	$I_G = 1.2 I_{GT}$	I - III - IV	MAX.	40	60	mA
		II		80	120	
dV/dt (2)	$V_D = 67\% V_{DRM}$ gate open	$T_j = 125^\circ\text{C}$	MIN.	200	400	V/ μs
$(dI/dt)_c$ (2)	$(dI/dt)_c = 7\text{ A/ms}$	$T_j = 125^\circ\text{C}$	MIN.	5	10	V/ μs

■ 静态特性:

Symbol	Test Conditions			Value	Unit	
$V_T(2)$	$I_{TM} = 22.5\text{ A}$	$t_p = 380\ \mu\text{s}$	$T_j = 25^\circ\text{C}$	MAX.	1.55	V
$V_{to}(2)$	Threshold voltage		$T_j = 125^\circ\text{C}$	MAX.	0.85	V
$R_d(2)$	Dynamic resistance		$T_j = 125^\circ\text{C}$	MAX.	25	m Ω
I_{DRM} I_{RRM}	$V_{DRM} = V_{RRM}$		$T_j = 25^\circ\text{C}$	MAX.	5	μA
			$T_j = 125^\circ\text{C}$		2	mA

Note 1: minimum I_{GT} is guaranteed at 5% of $I_{GT\text{ max}}$.

Note 2: for both polarities of A2 referenced to A1.

■ 热阻:

Symbol	Parameter		Value	Unit	
$R_{th(j-c)}$	Junction to case (AC)	D ² PAK / TO-220AB	1.2	$^\circ\text{C/W}$	
		TO-220AB Insulated	2.1		
$R_{th(j-a)}$	Junction to ambient	S = 1 cm ²	D ² PAK	45	$^\circ\text{C/W}$
			TO-220AB / TO-220AB Insulated	60	

S = Copper surface under tab.

■ 命名方式:

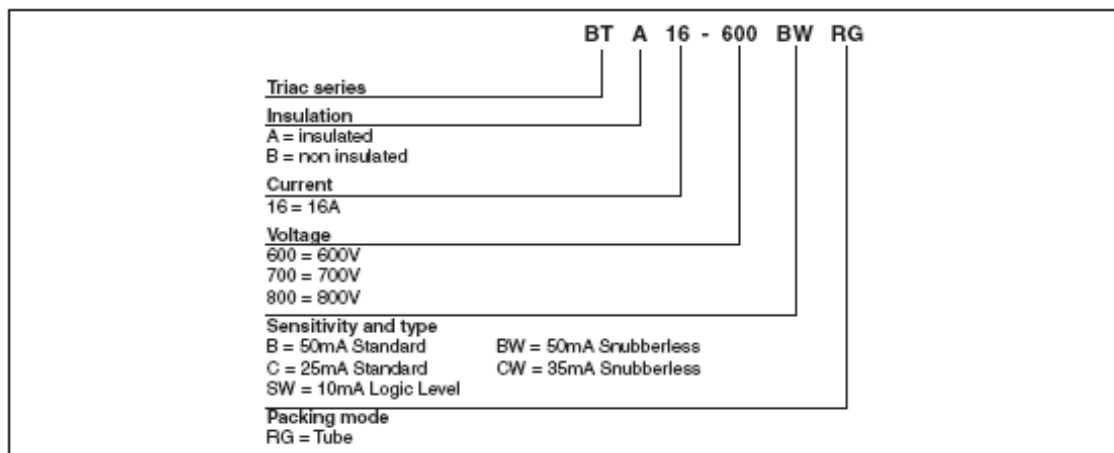

■ 特性曲线:

Figure 1: Maximum power dissipation versus RMS on-state current (full cycle)

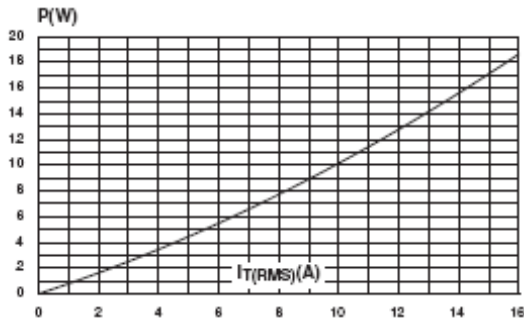

Figure 2: RMS on-state current versus case temperature (full cycle)

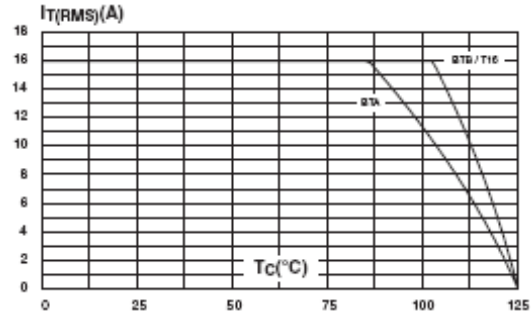

Figure 3: RMS on-state current versus ambient temperature (printed circuit board FR4, copper thickness: 35μm) (full cycle)

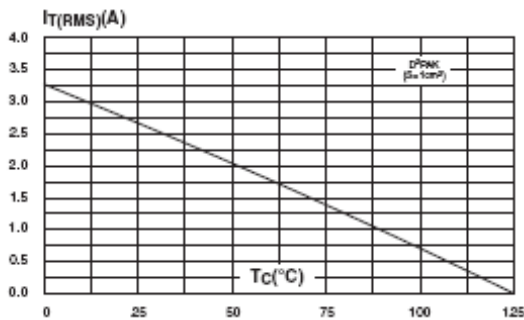

Figure 4: Relative variation of thermal impedance versus pulse duration

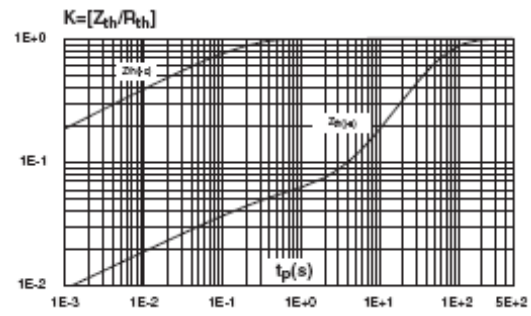

Figure 5: On-state characteristics (maximum values)

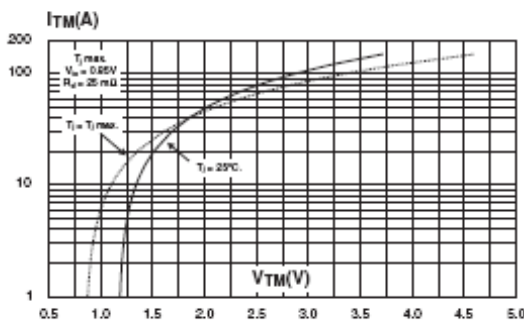
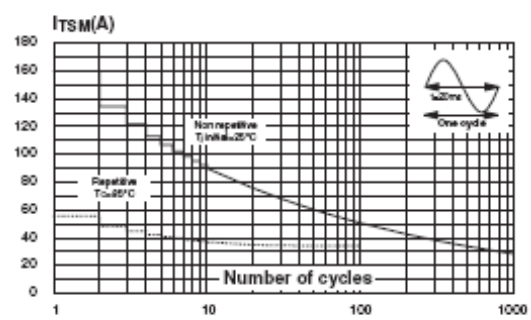

Figure 6: Surge peak on-state current versus number of cycles



■ 特性曲线:

Figure 7: Non-repetitive surge peak on-state current for a sinusoidal pulse with width $t_p < 10$ ms and corresponding value of I^2t

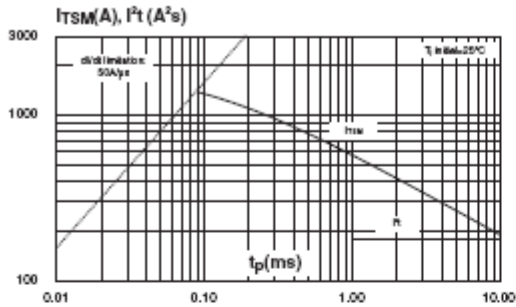

Figure 8: Relative variation of gate trigger current, holding current and latching current versus junction temperature (typical values)

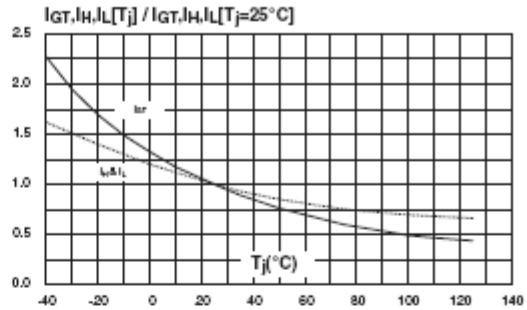

Figure 9: Relative variation of critical rate of decrease of main current versus $(dV/dt)_c$ (typical values) (Snubberless & Logic level types)

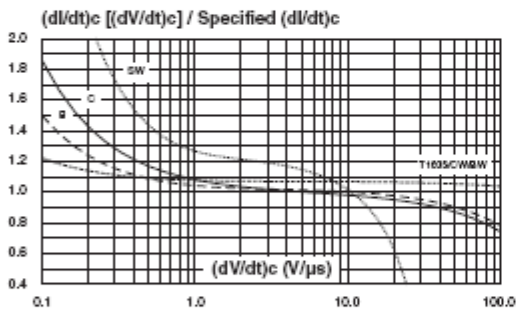

Figure 10: Relative variation of critical rate of decrease of main current versus $(dV/dt)_c$ (typical values) (Standard types)

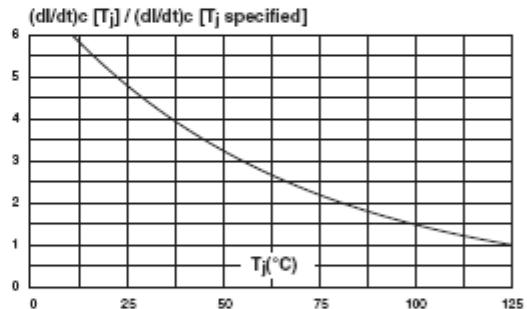
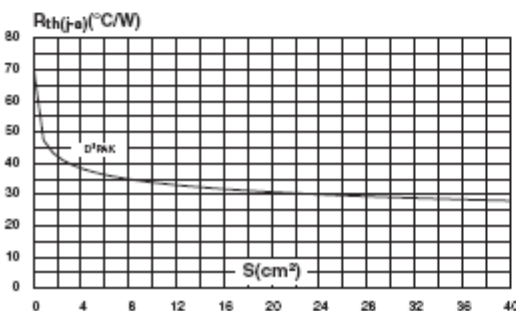

Figure 11: D²PAK Thermal resistance junction to ambient versus copper surface under tab (printed circuit board FR4, copper thickness: 35 μm)



■ TO-220AB/TO220ABInsulated 外形尺寸

